

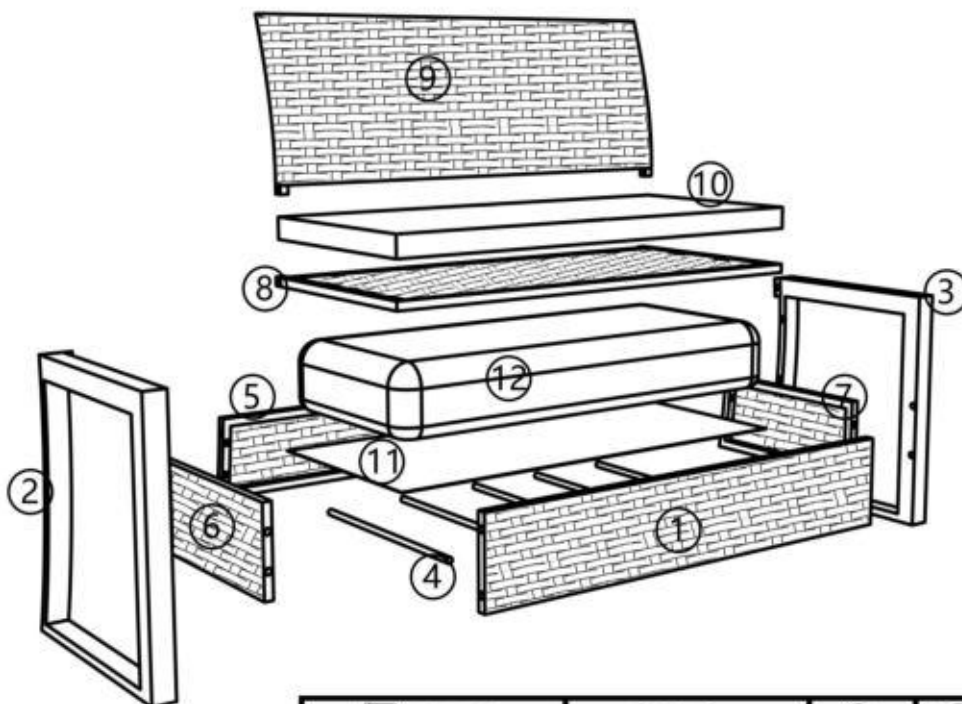

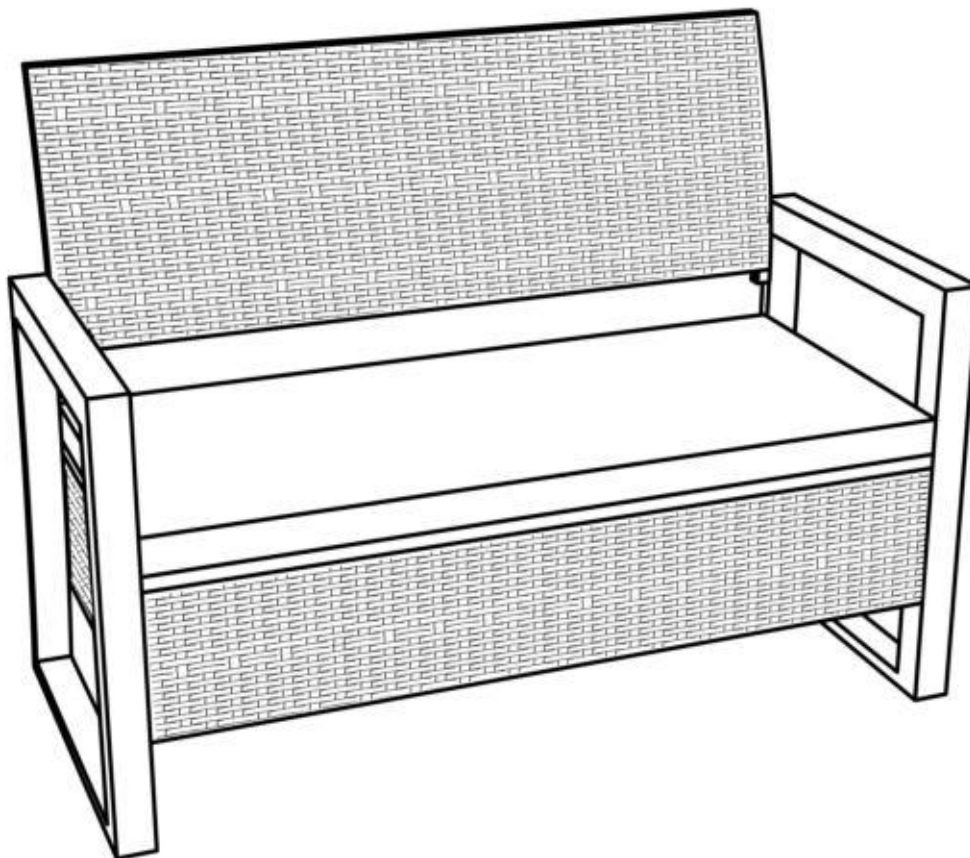



Aufbauanleitung

Assembly instructions / Instructions de montage / Istruzioni di montaggio /
Instrucciones de montaje

STS-TZ13



				
A=M6*40mm=18	B=M6*20mm=3	C=21	D=3	E=1

1

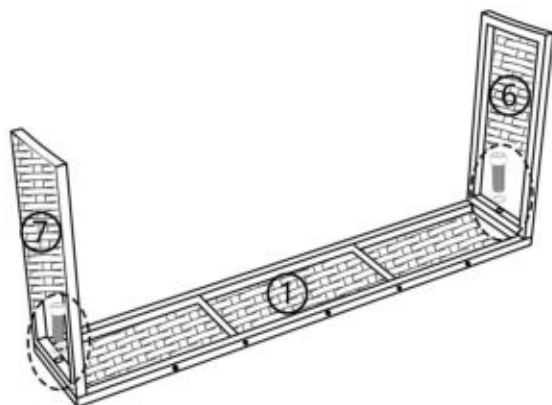

2

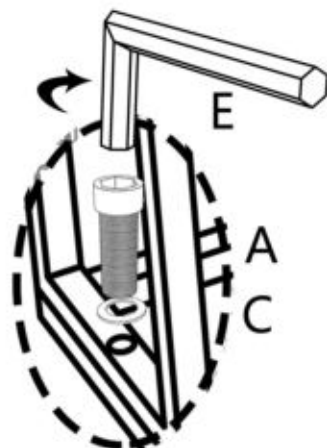
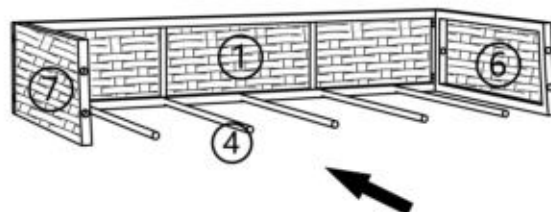

ACHTUNG: Platzieren Sie zuerst alle Schrauben an ihrem Platz, bevor Sie sie vollständig festziehen.

ATTENTION: Place first all screws on their place, before you tighten them up completely.

ATTENTION: Veuillez tout d'abord placer toutes les vis comme il le convient avant de les serrer.

ATTENZIONE: Posizionare tutte le viti al loro posto, prima di stringerle completamente.

PRECAUCION: Coloque todos los tornillos en su lugar, antes de apretarlos completamente.

3

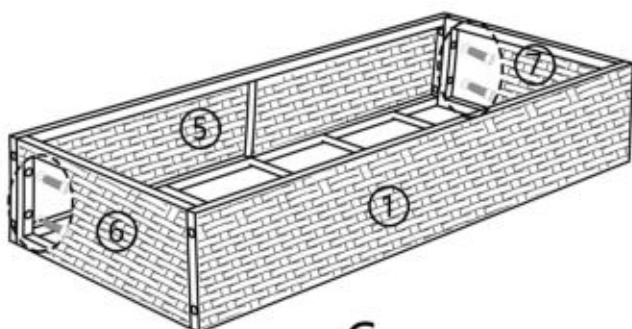

4

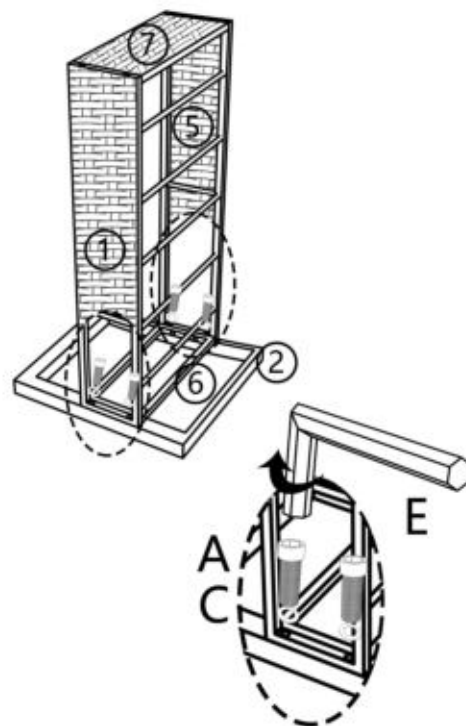
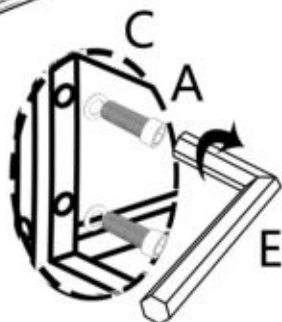

5

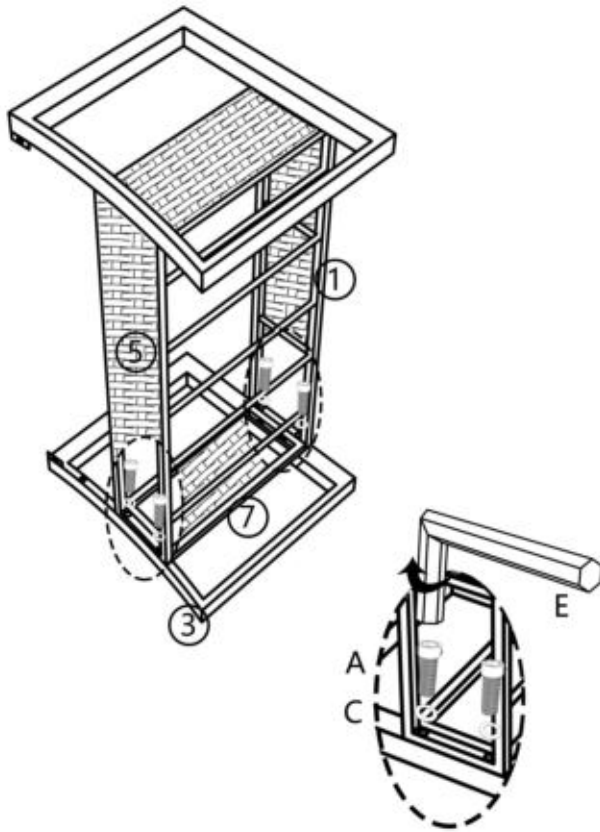

6

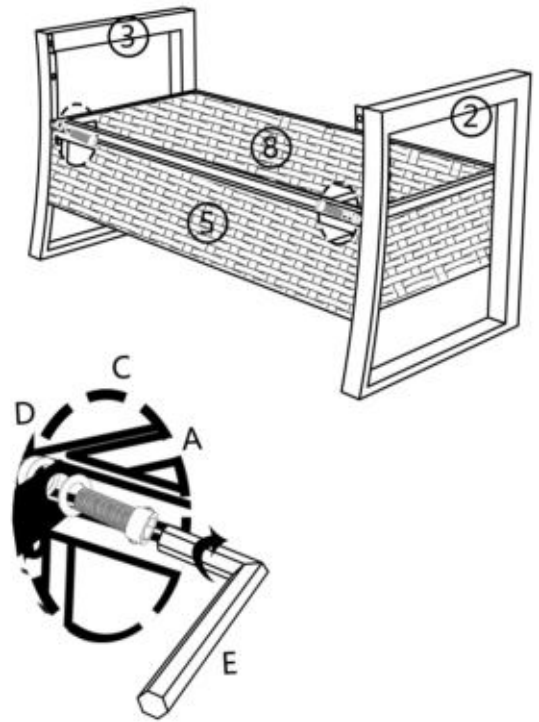

7

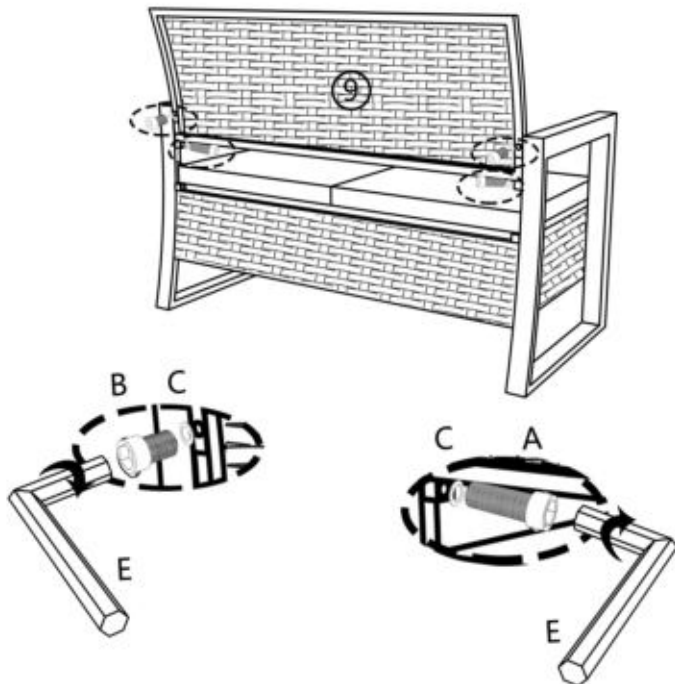

8

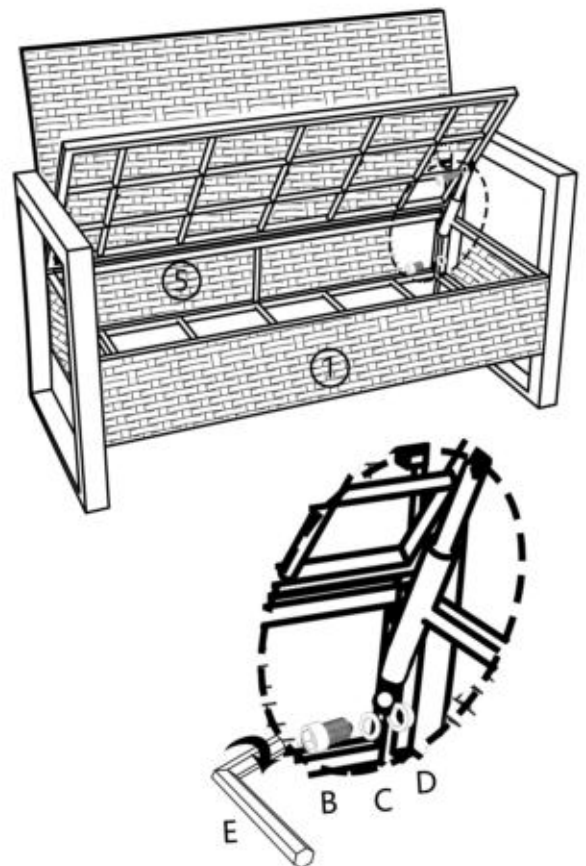

9

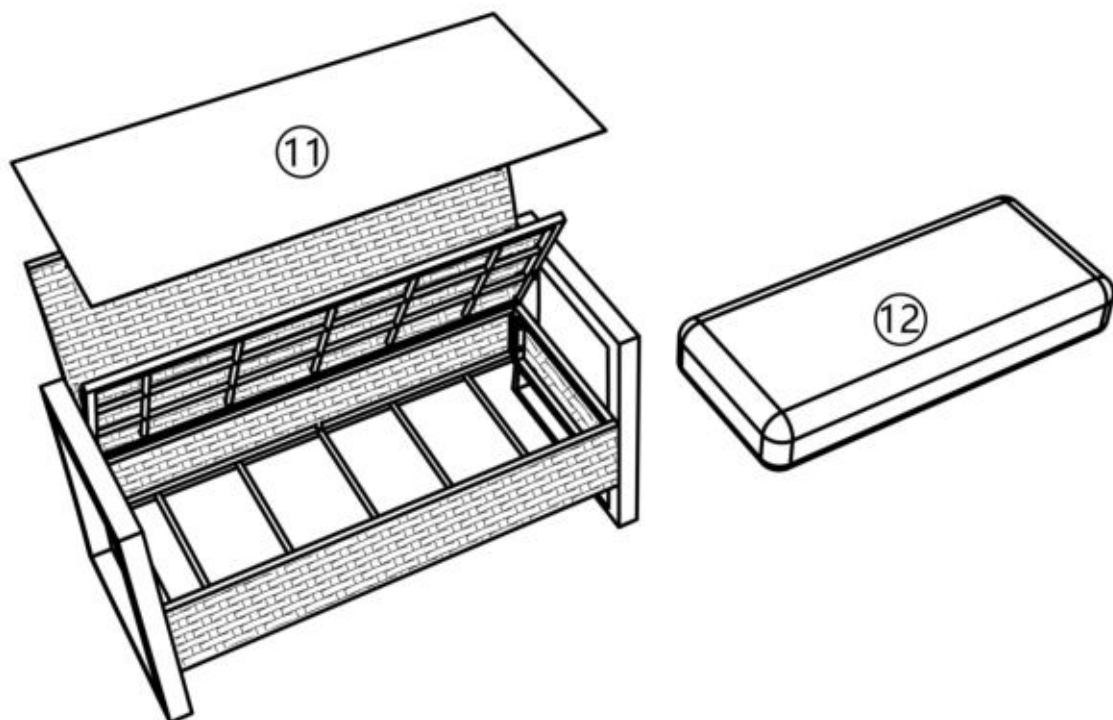

10

